

다중경로 페이딩 채널에서 데이터와 영상전송을 위한 OFDM/HL-16QAM 시스템의 성능 시뮬레이션

정희원 꺾 재민*, 박기식**, 조성언***, 김춘길****, 조성준*

The performance Simulation of OFDM/HL-16QAM System for Data and Image Transmission in Multipath Fading Channel

Jae-min Kwak*, Ki-sik Park**, Sung-eon Cho***, Chun-gil Kim****, Sung-joon Cho* *Regular Members*

요 약

본 논문에서는 OFDM/HL-16QAM 시스템의 성능을 구하였다. OFDM/HL-16QAM은 계층적 16QAM을 채용하는 OFDM 시스템으로서 열악한 다중경로 페이딩 환경에서 고품질의 고속 데이터 전송이 가능하고 서로 다른 품질의 두가지 데이터 서비스를 동시에 제공할 수 있는 시스템이다. 성능평가를 위한 무선 채널로서는 AWGN과 다중경로 페이딩이 존재하는 무선 환경을 고려했다.

각각의 채널환경에서의 시뮬레이션을 통해 데이터 전송시의 OFDM/HL-16QAM 시스템에 대해 Eb/No와 반송파 수에 따른 BER 성능을 구해냈고, 이로부터 고품질과 저품질의 데이터 서비스를 모두 만족시키기 위해 요구되는 최소 평균 SNR 값을 제시했다. 이미지 전송에 응용하기 위한 방안으로는, 영상 압축을 위해 DCT 기반의 고정길이 부호기법을 채용하는 OFDM/HL-16QAM 시스템을 제안하고, 수신 영상의 PSNR(Peak Signal to Noise power Ratio)을 최대화시키는 최적 계층 변조 파라미터를 구했다. 또한, 최적화된 계층 변조 파라미터를 사용하는 경우, 제안한 시스템을 통한 수신 영상 품질이 기존의 OFDM/16QAM 시스템보다 우수하다는 것을 보였고, 시뮬레이션을 통해 수신 영상에 대한 PSNR의 상한과 하한을 구해냈다.

성능분석 결과들로부터 제안한 OFDM/HL-16QAM 시스템이 데이터와 이미지 전송에 적합한 시스템이라는 것을 알 수 있다.

ABSTRACT

In this paper, we have evaluated the performance of an OFDM/HL-16QAM system for achieving high speed data and high quality image transmission. OFDM/HL-16QAM system is an OFDM system which employs a hierarchical 16QAM and has the capability of reliable high speed data service and simultaneous transmission of differentiated two quality of data streams in severe multipath fading channel. The wireless channel for performance evaluation is assumed to include AWGN and multipath fading.

Through simulation, we have obtained the BER performance of the OFDM/HL-16QAM system for data transmission according to Eb/No and the number of subcarriers, and then suggest the minimum required average SNR to satisfy both high quality and low quality of data services. For application of image transmission, we have proposed the OFDM/HL-16QAM system adopting fixed length DCT based coding to achieve reasonable image compression rate and obtained the optimal hierarchical modulation parameter maximizing PSNR(Peak Signal to Noise power Ratio) of received still image. Then, it has been shown that the received image quality of the

* 한국항공대학교 대학원 항공통신정보공학과

** 인하공업전문대학 정보통신과

*** 순천대학교 정보통신공학과

**** 한국과학기술원 자연과학부

논문번호 : 010122-0524, 접수일자 : 2001년 5월 24일

proposed system with optimized hierarchical modulation parameter is better than that of conventional OFDM/16QAM system. Also, the upper bound and lower bound of PSNR achieved by the proposed system are obtained.

From the result, it is found that the OFDM/HL-16QAM system is more effective for mobile multimedia services.

I. Introduction

Recently, there has been an increasing demand for multimedia transmission, such as the transmission of text data, voice and images, in mobile communication systems [1],[2]. In order to provide such multimedia services with high speed transmission and higher bandwidth efficiency, OFDM is expected to be the most appropriate scheme.

In OFDM, transmission is carried out in parallel on the different frequencies [3]-[5]. That is, the entire channel is divided into many narrow band subchannels, which are transmitted in parallel, thereby, increasing the symbol duration and reducing the ISI. The carrier spacing is selected such that modulated carriers are orthogonal over a symbol interval. In addition, a guard interval (cyclic prefix) is inserted in order to combat the frequency selectivity of the channel. Therefore, OFDM is an effective technique for combating against multipath fading and for high-bit-rate transmission over mobile wireless channels [6],[7].

In paper [1], hierarchical transmission system was proposed to transmit still image in mobile communication. The system composed of hierarchical source coder and corresponding channel coder, divides the information into several layers according to their significance, and transmits each layer with different reliability according to their layers. Some source coding schemes, such as DCT (Discrete Cosine Transform), can divide image into several part according its spatial frequency. These characteristics of DCT and unequal reliability of transmission according to importance of the DCT transformed image data can be used for high quality image transmission. In paper [8], the performance of an image transmission system

employing DCT based fixed length coding scheme for achieving reasonable compression rate was evaluated in fading environment.

In this paper, we obtain the BER performance of OFDM system employing hierarchical 16QAM (OFDM/HL-16QAM system) for data transmission by simulation. Then, we show that the system is more effective than conventional OFDM/16QAM on multipath fading channel in point of required E_b/N_0 to meet high quality and low quality of data services simultaneously. Next, we propose the OFDM/HL-16QAM system adopting DCT based fixed length coding scheme and show that the system is effective for image transmission by comparing received image quality of OFDM/HL-16QAM system with that of OFDM/16QAM system. Also, the optimum hierarchical parameter maximizing the received image PSNR(Peak Signal to Noise power Ratio) is suggested and the upper bound and lower bound of PSNR achieved by the proposed system are obtained.

This paper is organized as follows. In section 2. the principle of hierarchical 16QAM system adopting DCT based fixed length coding is described. Section 3 shows the system model of proposed OFDM/HL-16QAM and the signal representation of OFDM system. In section 4, simulation results are represented and the paper is concluded in section 5.

II. Hierarchical 16QAM with DCT based fixed length coding

The block diagram of hierarchical 16QAM system is shown in figure 1. After an image source data is divided into subblocks, they are converted to frequency domain by 2 dimensional DCT. Then, DCT coefficients are quantized, and DCT based fixed length coding is applied for image compression as shown in figure 2 ("lenna"

: 256 level monochrome image) . By using the bits allocation map in figure 2, where the number in each square shows the number of bits allocated for each DCT quantized coefficient, one subblock image (8×8 pixels, 8 bits per pixel) is compressed (compression rate : 22.27%), and the compressed image results in 30.7[dB] of PSNR. In this paper, these DCT based fixed length coded data are divided again to lower frequency components (base layer) and higher frequency components (refinement layer), then final hierarchical 16QAM mapped output signals which consists of 4 bits (two bits from base layer and two bits from refinement layer) are generated.

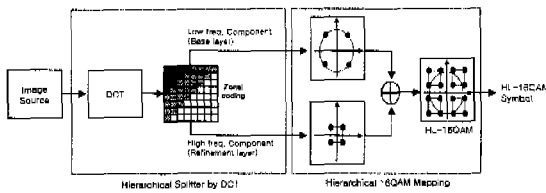

Fig. 1 Block diagram of hierarchical 16QAM system with DCT based fixed length coding.

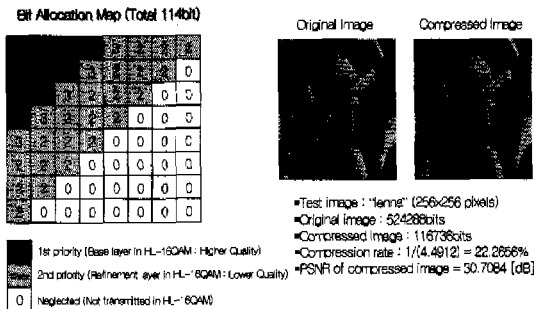

Fig. 2 Bit allocation map and the test image "Lenna" (256 level monochrome) with no transmission error.

The constellation diagram of hierarchical 16QAM modulation is shown in figure 3. In this figure, D_1 and D_2 are the minimum distance between clusters and the minimum distance within the cluster, respectively. The first two bits (base layer) determine the one of the four subplanes and the next two bits (refinement layer) determine one of the four constellation points within a cluster, respectively. In this system, by controlling hierarchical modulation parameter ($\lambda = D_2/D_1$), the

performance of each two layered bits can be adjusted. In AWGN channel, the BER (P_{e1}) of base layer and the BER (P_{e2}) of refinement layer are approximately given by [9],

$$P_{e1} = \frac{1}{4} \operatorname{erfc}\left(\sqrt{\frac{\gamma}{4\lambda^2 + 4\lambda + 2}}\right) + \frac{1}{4} \operatorname{erfc}\left(\sqrt{\gamma \cdot \frac{4\lambda^2 + 4\lambda + 1}{4\lambda^2 + 4\lambda + 2}}\right) \quad (1)$$

and

$$P_{e2} = \frac{1}{2} \operatorname{erfc}\left(\sqrt{\frac{\lambda^2 \gamma}{4\lambda^2 + 4\lambda + 2}}\right), \quad (2)$$

where γ is the CNR at the receiver front end and $\operatorname{erfc}(\cdot)$ is complementary error function defined by, $\operatorname{erfc}(x) = \frac{2}{\sqrt{\pi}} \int_x^\infty \exp(-t^2) dt$.

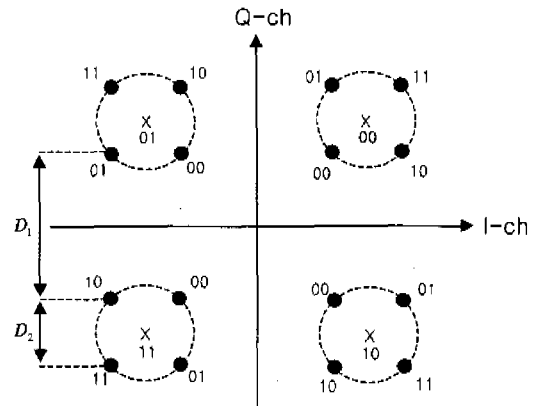

Fig. 3 Constellation diagram of the hierarchical 16QAM.

Since the hierarchical 16QAM mapping has input bits which is coded by DCT based fixed length coding, it is expected that the reasonable compression rate can be obtained and there may be the optimum hierarchical modulation parameter maximizing the PSNR of reconstructed image at the receiver in fading environments. The PSNR of 256 level monochrome image is defined as [8],

$$PSNR = 10 \log_{10} \frac{255^2}{\sigma_q^2} [dB]. \quad (3)$$

σ_q^2 is the mean square of the difference between the original image and the compressed one.

III. System Model of OFDM System employing Hierarchical 16QAM

The block diagram of OFDM transmitter employing hierarchical 16QAM is represented in figure 4, where, for simplicity, we have ignored the filters inherent in all communication systems. The N serial hierarchical 16QAM data symbols, spaced by $\Delta t = 1/f_s$ where f_s is the symbol rate and Δt is symbol duration of serial data, are first converted to parallel form by the serial-to-parallel (S/P) converter and then modulate N subcarriers. The modulated subcarriers are all added, multiplied by the carrier, and then transmitted to the channel. The constellation of the system is represented in figure 3. The subcarrier frequencies are separated by multiples of $1/T$ so that, if signal is not distorted in transmission, the coherent detection of a signal element in any one subchannel of the parallel system gives no output for the received element in any other subchannel. $s'(t)$ is modulated signal by product operation of $s(t)$ and $e^{j2\pi f_c t}$.

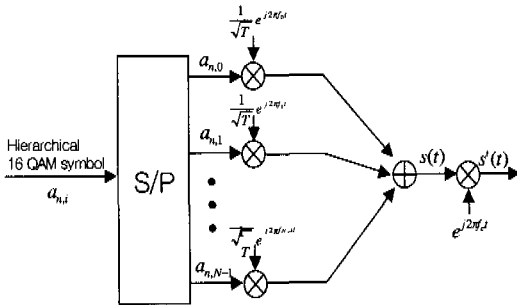

Fig. 4 The structure of OFDM transmitter.

The generated equivalent complex baseband OFDM signal is written as

$$s(t) = \sum_{n=-\infty}^{\infty} \sum_{i=0}^{N-1} \frac{A}{\sqrt{T}} a_{n,i} e^{j2\pi f_i t} p(t - nT_s), \quad (4)$$

where A is a constant related to the signal power, T_s is the symbol duration, $a_{n,i}$ is the hierarchical 16QAM symbol transmitted to the i -th subchannel in the n -th OFDM symbol interval

$[nT_s, (n+1)T_s]$ and f_i is the frequency of the i -th subcarrier. $p(t)$ is a pulse shaping function expressed as

$$p(t) = \begin{cases} 1, & T_g \leq t \leq T_s \\ 0, & \text{otherwise} \end{cases}, \quad (5)$$

where T_g is a guard interval of OFDM signal. The time difference between the symbol period T_s and the guard interval T_g is the effective symbol interval.

Since the orthogonality condition should be satisfied, f_i is represented as

$$f_i = \frac{i}{T} = \frac{i}{N\Delta t}. \quad (6)$$

The transmitted OFDM signal represented in equation (4) passes through multipath fading channel modeled by two ray model. This two ray model represented in figure 5 well describes multipath propagation of VHF/UHF band [10]. The simplified impulse response of the fading channel considered in this paper is expressed as [11]

$$h(t) = \delta(t) + b\delta(t - \tau)e^{j\theta}, \quad (7)$$

where the parameters b , τ , and θ are respectively the amplitude, time of arrival, and random phase of delayed multipath components. In figure 5, we assumed that b and τ are constant value but θ is random variable uniformly distributed in $[0, 2\pi)$.

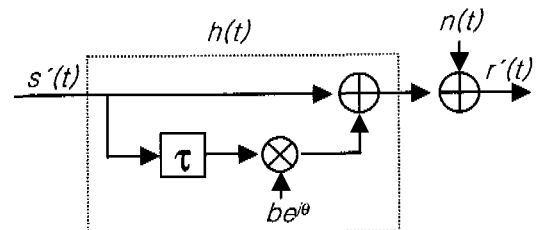

Fig. 5 Two ray multipath channel model.

Figure 6 shows the structure of the general OFDM system receiver. At first, the received signal is multiplied by the carrier frequencies, and then passes through a bank of correlators. Finally,

the coherently detected symbols are converted to the serial stream by the parallel-to-serial (P/S) converter.

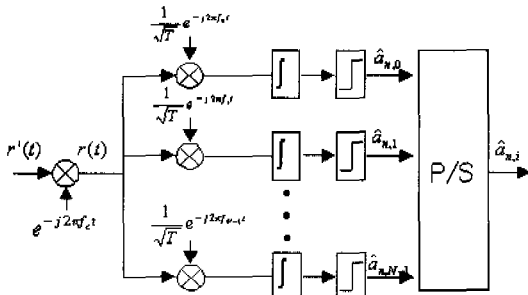

Fig. 6 The structure of OFDM receiver.

The received signal after passing through multipath channel is represented as

$$r'(t) = s'(t) * h(t) + n(t) \tag{8}$$

$$= s'(t) + bs'(t - \tau)e^{j\theta} + n(t) ,$$

where “*” represents a convolution operation and n(t) is the additive white Gaussian noise with the double sided power spectral density of $N_0/2$. In the first part of the OFDM/HL-16QAM receiver, the signal is down converted to the baseband. The down converted signal is given as

$$r(t) = r'(t)e^{-2\pi f_c t} \tag{9}$$

$$= y(t) + n(t)e^{-2\pi f_c t} ,$$

where f_c is the carrier frequency, and $y(t)$ is the signal component of $r(t)$ as to be [12],[13]

$$y(t) = \frac{A}{\sqrt{T}} \sum_{n=-\infty}^{\infty} \sum_{i=0}^{N-1} a_{n,i} e^{j2\pi f_c t} p(t - nT_s) \tag{10}$$

$$+ \frac{Ab}{\sqrt{T}} e^{-j2\pi f_c \tau} e^{j\theta} \sum_{n=-\infty}^{\infty} \sum_{i=0}^{N-1} e^{j2\pi f_c (t-\tau)} p(t - \tau - nT_s)$$

IV. Simulation Results

Figure 7 shows the simulation block diagram of OFDM/HL-16QAM system in two ray multipath fading channel, where the upper path is transmitter and the lower path corresponds to the receiver. After the generated bit streams are first

mapped to hierarchical 16QAM symbols and the serial symbol streams are converted to parallel form, zero bits are inserted to this parallel form symbols. Then IFFT block is used to modulate a block of input hierarchical 16QAM symbols onto a number of subcarriers. These modulated parallel data are converted to serial form of symbols, which become OFDM/HL-16QAM signal. In the receiver, signal demodulation process is performed in reverse order of transmitter operation.

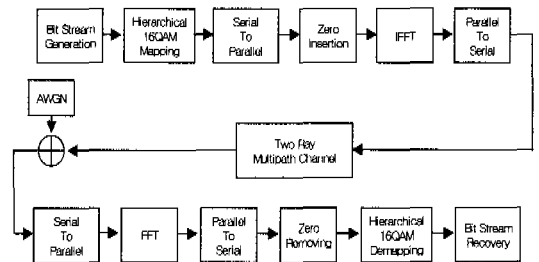

Fig. 7 Simulation block diagram of OFDM/HL-16QAM system.

Simulation results on the bit error probability have been obtained on the specific channel condition. The system and channel parameter values used for simulation of OFDM/HL -16QAM system is presented in Table 1. In this simulation, the guard time is not included, so effective OFDM symbol interval is equal to FFT interval at the receiver.

Table 1. Parameters for simulation.

Parameters	Values
Modulation type	Hierarchical 16QAM
Normalized delay(τ/T)	0.0303 (= 31/1024)
Attenuation coefficient (b)	-6dB
Number of subcarriers	64
Hierarchical modulation parameter (λ)	0.1 ~ 1.0

1. Data Transmission

Figure 8 represents the time signal waveform of OFDM/16QAM with 64 subcarriers. To obtain actual OFDM signal waveform, after 960 zeros are added to 64 input data, 1024 point complex

IFFT is operated. Considered OFDM symbol is comprised of 1024 output samples from complex IFFT. These output samples are complex values, so plot of real samples (a) and imaginary samples (b) are simulated, respectively.

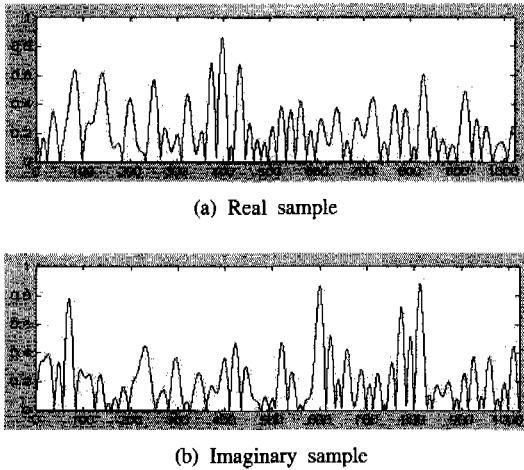

Fig. 8 Time signal of OFDM/16QAM system with 64 subcarriers.

Figure 9 depicts three constellation diagrams that are derived from simulation of an OFDM/HL-16QAM system with 64 subcarriers, each modulated by using hierarchical 16QAM. Figure 9 (a), (b), and (c) show the constellation corresponding to hierarchical modulation parameter ($\lambda = 1$), ($\lambda = 0.5$), and ($\lambda = 0$), respectively. Figure 9 (a) and (c) are the same as 16QAM and QPSK constellation, respectively. However, since the hierarchical parameter λ control the reliability of each layer, the first half two bits within a symbol (base layer) is more robust to channel distortion than the last half two bits (refinement layer) within it. In these figures, though the positions of each constellation point are different, mean signal powers of the three constellation diagram are the same.

Figure 10 ~ figure 12 show the BER performances of OFDM/HL-16QAM system. These figures commonly show that the hierarchical 16QAM modulator improves the BER of base layer transmission at the sacrifice of refinement layer's BER.

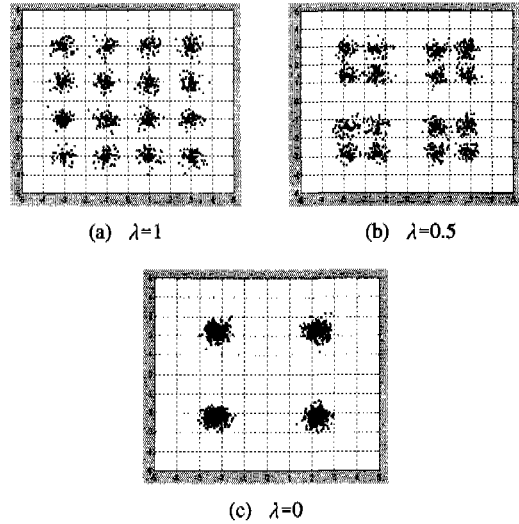

Fig. 9 Constellation for the OFDM/HL-16QAM system in two ray multipath channel ($E_b/N_0 = 40$ dB).

Figure 10 shows the BER performances of OFDM/HL-16QAM system with 64 subcarriers in AWGN channel. It is shown that the BER performance of base layer is improved and refinement layer is degraded as λ is decreased. In this case, when two quality of data services with BER 10^{-2} and BER 10^{-3} are required, conventional OFDM/16QAM system and OFDM/HL-16QAM system with $\lambda = 1$ need about 10.7 dB and 10.1 dB in terms of E_b/N_0 , respectively. From this result, it is assured that OFDM/HL-16QAM system is relatively suitable for mobile multimedia communication requiring multi-reliability of data services.

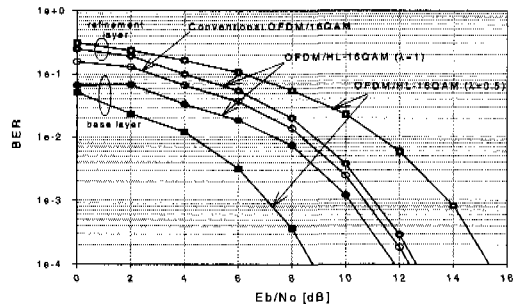

Fig. 10 BER performance of OFDM/HL-16QAM system in AWGN channel.

Figure 11 represents the BER performance of

OFDM/HL-16QAM with 8 dB of E_b/N_0 versus the number of subcarriers in two ray multipath fading channel with constant normalized delay ($\tau/T=0.0303$). For OFDM systems in multipath fading environment, ICI (Inter Channel Interference) becomes more serious interference component as the number of subcarriers is increased. In this figure, as the number of subcarriers increases, the BER performance of OFDM/HL-16QAM system is degraded. Especially, the performance of OFDM/HL-16QAM system with $\lambda=0.5$, performance difference between base layer and refinement layer according to the number of subcarriers is dramatically changed.

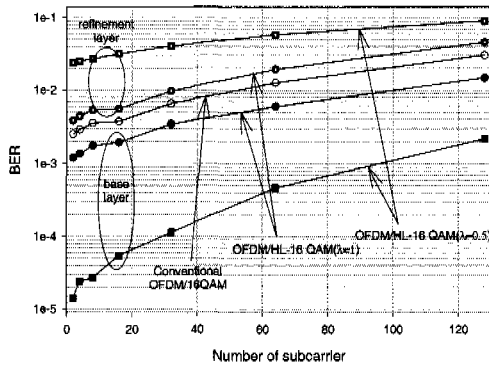

Fig. 11 BER performance of OFDM/HL-16QAM system according to the number of subcarriers in two ray multipath fading channel ($E_b/N_0=8$ [dB]).

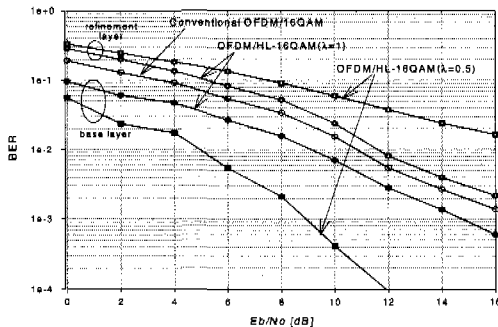

Fig. 12 BER performance of OFDM/HL-16QAM system in two ray multipath fading channel.

Figure 12 shows the BER performance of OFDM/16QAM system with 64 subcarriers in two ray multipath fading channel. It is also shown

that the BER performance of base layer is improved and refinement layer is degraded as λ is decreased. When two different quality of data services with BER 10^{-2} and BER 10^{-3} are required to be transmitted simultaneously, conventional OFDM/16QAM system and OFDM/HL-16QAM with $\lambda=1$ need about 17 dB and 14.8 dB in terms of E_b/N_0 , respectively.

Therefore, OFDM/HL-16QAM system can be operated with less power compared with conventional OFDM/16QAM when the two different target performances are required.

2. Still Image Transmission

For the simulation of image transmission, we use an image "lenna" shown in figure 2. Table 2 shows instantaneous PSNR performance of the received images of the proposed OFDM/HL-16QAM with DCT based fixed length coding against λ and E_b/N_0 . The bit allocation map for image compression and simulation condition are previously presented in figure 2 and table 1, respectively.

Table 2. PSNR in dB according to λ and E_b/N_0

λ \ E_b/N_0	0dB	2dB	4dB	6dB	8dB	10dB	12dB	14dB	16dB
0.1	13.97	15.50	16.77	17.28	17.48	17.70	17.90	18.17	18.37
0.2	13.69	15.41	16.81	17.85	18.60	19.14	19.92	20.58	21.30
0.3	13.04	14.97	16.94	18.62	19.81	20.96	22.27	23.64	24.66
0.4	12.45	14.13	16.50	19.02	20.99	22.78	24.45	26.28	27.60
0.5	12.21	13.67	16.01	18.98	21.79	24.21	26.52	28.16	29.35
0.6	11.96	13.39	15.53	18.74	22.49	25.77	28.17	29.56	30.25
0.7	11.44	12.79	14.91	17.90	22.65	26.28	28.69	30.13	30.50
0.8	11.09	12.61	14.32	17.21	21.26	26.68	28.78	30.40	30.67
0.9	11.10	12.19	14.18	16.53	20.61	25.83	29.30	30.59	30.69
1.0	10.88	11.78	13.23	15.60	19.74	23.37	28.43	30.54	30.44

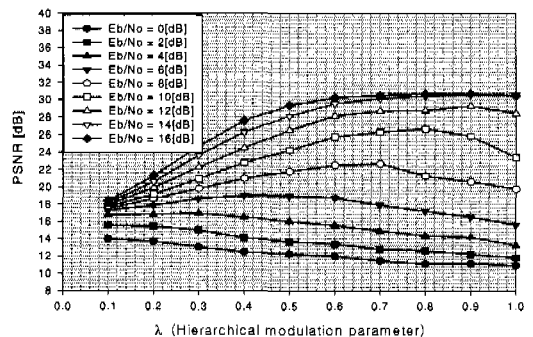

Fig. 13 PSNR performance of the received images according to λ

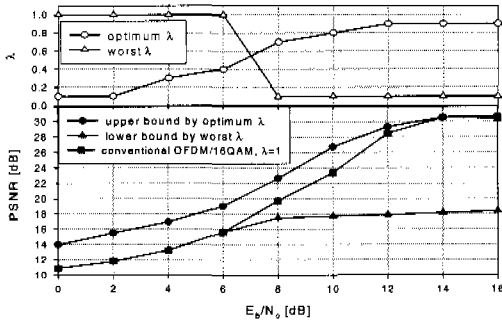

Fig. 14 Upper and lower bound of PSNR according to optimum and worst λ obtained through simulation.

Figure 13 shows the PSNR performance graph obtained from table 2. From the table 2 and figure 13, it is shown that optimum λ maximizing PSNR exists according to E_b/N_0 value and the optimum λ becomes higher as E_b/N_0 increases. Figure 14 shows the optimum λ and worst λ according to E_b/N_0 and PSNR performance corresponding to optimum and worst case. From



(a) original image



(b) PSNR=30.71[dB](no transmission error)



(c) PSNR=26.68[dB]($\lambda=0.8$, $E_b/N_0=10$ [dB])



(d) PSNR=23.37[dB]($\lambda=1.0$, $E_b/N_0=10$ [dB])

Fig. 15 Example of reconstructed image at the receiver

the figure, we have found that the proposed system with optimum λ has reasonable gain in PSNR as compared with conventional OFDM/16QAM ($\lambda=1$) system. Especially, the more gain is achieved by the proposed system as E_b/N_0 becomes small.

In figure 15, we have shown examples of simulated image. Figure 15 (a) is the original image and figure 15 (b) is an image compressed by DCT based fixed length coding without transmission error. The bit allocation map is given in figure 2. Figure 15 (c) and (d) are received images of the OFDM/HL-16QAM with DCT based fixed length coding with optimum λ and conventional OFDM/16QAM ($\lambda=1$) over two ray fading channel.

V. Conclusion

In this paper, we have proposed an OFDM/HL-

16QAM system for data and image transmission. And then, we have evaluated the performance of the system in AWGN and multipath fading channel.

Through simulation, we have obtained the BER performance of the OFDM/HL-16QAM system for data transmission and determined the minimum required average SNR to satisfy both high quality and low quality of data services. For image transmission, we have proposed the OFDM/HL-16QAM system adopting fixed length DCT based coding, and then obtained the optimum hierarchical modulation parameter maximizing PSNR of received still image. It has been shown that the received image quality of the proposed system with optimized hierarchical modulation parameter is better than that of conventional OFDM/16QAM system. Also, the upper bound and lower bound of PSNR achieved by the proposed system are presented.

Therefore, it is concluded that the proposed OFDM/HL-16QAM system is suitable for mobile multimedia communication demanding multi-reliability of data and high quality image transmission.

Reference

[1] Y. Sakamoto, M. Morimoto, M. Okada, and S. Komaki, "A wireless multimedia communication system using hierarchical modulation," *IEICE Trans. Commun.*, vol. E81-B, no. 12, Dec. 1998.

[2] E. K. Wesel, *Wireless Multimedia Communications*, Addison Wesley, 1998.

[3] S. B. Weinstein and P. M. Ebert, "Data transmission by frequency-division multiplexing using the discrete fourier transform," *IEEE Trans. Commun., Tech.*, vol. COM-19, no. 5, pp. 628-634, Oct. 1971.

[4] J. A. C. Bingham, "Multicarrier modulation for data transmission : An idea whose time has come," *IEEE Commun. Magazine*, vol. 28, no. 5, pp. 5-15, May 1990.

[5] W. Y. Zou and Y. Wu, "COFDM : An

overview," *IEEE Trans. on Broadcasting*, vol. 41, no. 1, pp. 1-8, March 1995.

[6] Richard Van Nee, Ramjee Prasad, *OFDM for Wireless Multimedia Communication*, Artech House, 2000.

[7] R. Prasad, *Universal Wireless Personal Communications*, Boston · London: Artech, 1998.

[8] K. Ogura, A. Miyazaki, and Y. Akaiwa, "An error resilient still image transmission system for mobile radio communication," *Vehicular Technology Conference*, vol. 3, pp. 2004-2008, 1999.

[9] M. Morimoto, M. Okada, and S. Komaki, "A hierarchical image transmission system for multimedia mobile communication," *IEICE Trans. Commun.*, vol. E80-B, no. 15, Dec. 1997.

[10] N. A. B. Svensson, "On optimum and suboptimum coherent detection of continuous phase modulation on a two-ray multipath fading channel," *IEEE Trans. Commun.*, vol. 35, pp. 1041-1049, Oct. 1987.

[11] M. Sylvain, "Extension of normalized two ray transfer function model to a space diversity line of sight link," *IEEE Trans. Commun.*, vol. 43, pp. 2271-2280, no. 7 July 1995.

[12] Y. Chung and S. Lee, "Performance analysis of OFDM on the multi-path fading channel," *J. Korean Institute of Communication Sciences*, vol. 21, no. 11, pp. 2923-2931, Nov. 1996.

[13] W. Hwang and K. Kim, "Performance analysis of OFDM on the shadowed multipath channels," *IEEE Trans. Consum. Elec.*, vol. 44, no. 4 pp. 1323-1328, Oct. 1987.

곽 재 민(Jae-min Kwak)

정희원

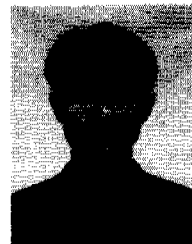

1998년 2월 : 한국항공대학교
항공통신정보공학과
(공학사)

1999년 8월 : 한국항공대학교
대학원 항공통신정보공
학과 (공학석사)

1999년 9월~현재 : 한국항공대학교 대학원 항공통신
정보공학과 박사과정
<주관심 분야> 이동통신, 무선랜, IMT-2000

박기식(Ki-sik Park) 정회원

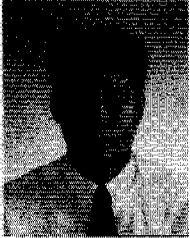

1991년 2월 : 한국항공대학교
항공통신정보공학과
(공학사)
1996년 8월 : 한국항공대학교
대학원 항공통신정보공
학과 (공학석사)

2000년 2월 : 한국항공대학교 대학원 항공통신정보
공학과 (공학박사)
2001년 2월~현재 : 인하공업전문대학 정보통신과
전임강사
<주관심 분야> 무선통신, WATM, 무선 광통신

조성연(Sung-eon Cho) 정회원



1989년 2월 : 한국항공대학교
항공통신정보공학과
(공학사)
1991년 2월 : 한국항공대학교
대학원 항공통신정보공
학과 (공학석사)

1997년 2월 : 한국항공대학교 대학원 항공통신정보
공학과 (공학박사)
1997년 9월~현재 : (국립)순천대학교 정보통신공학
과 조교수
<주관심 분야> 무선통신, 환경전자공학

김춘길(Chun-gil Kim) 정회원

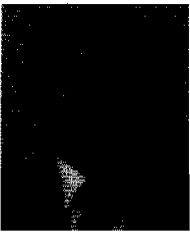

1965년 2월 : 한국항공대학교
항공전자공학과
(공학사)
1983년 9월 : 명지대학교 전자
공학과 (공학석사)
1993년 2월 : 한국항공대학교
항공전자공학과
(공학박사)

1988년 4월~1990년 4월 : 독일 Gesamt Hochschule/
Universität Kassel 연수

1996년 3월~1996년 6월 미국 University of Southern
California 교환교수

1984년 3월~현재 : 한국과학기술원 자연과학부 기초
과학과정 부교수

<주관심 분야> 통신정보처리시스템, 무선통신

조성준(Sung-joon Cho) 정회원

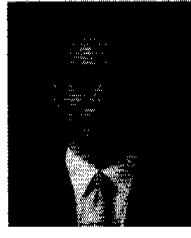

1969년 2월 : 한국항공대학교
항공통신공학과
(공학사)
1975년 2월 : 한양대학교 대학원
(공학석사)
1981년 2월 : 오사카대학교
대학원 통신공학과
(공학박사)

1972년 8월~현재 : 한국항공대학교 전자·정보통신
·컴퓨터공학부 교수, 대학원 항공통신
정보공학과 교수

<주관심 분야> 무선통신, 이동통신, 환경전자공학